

**PLIP**

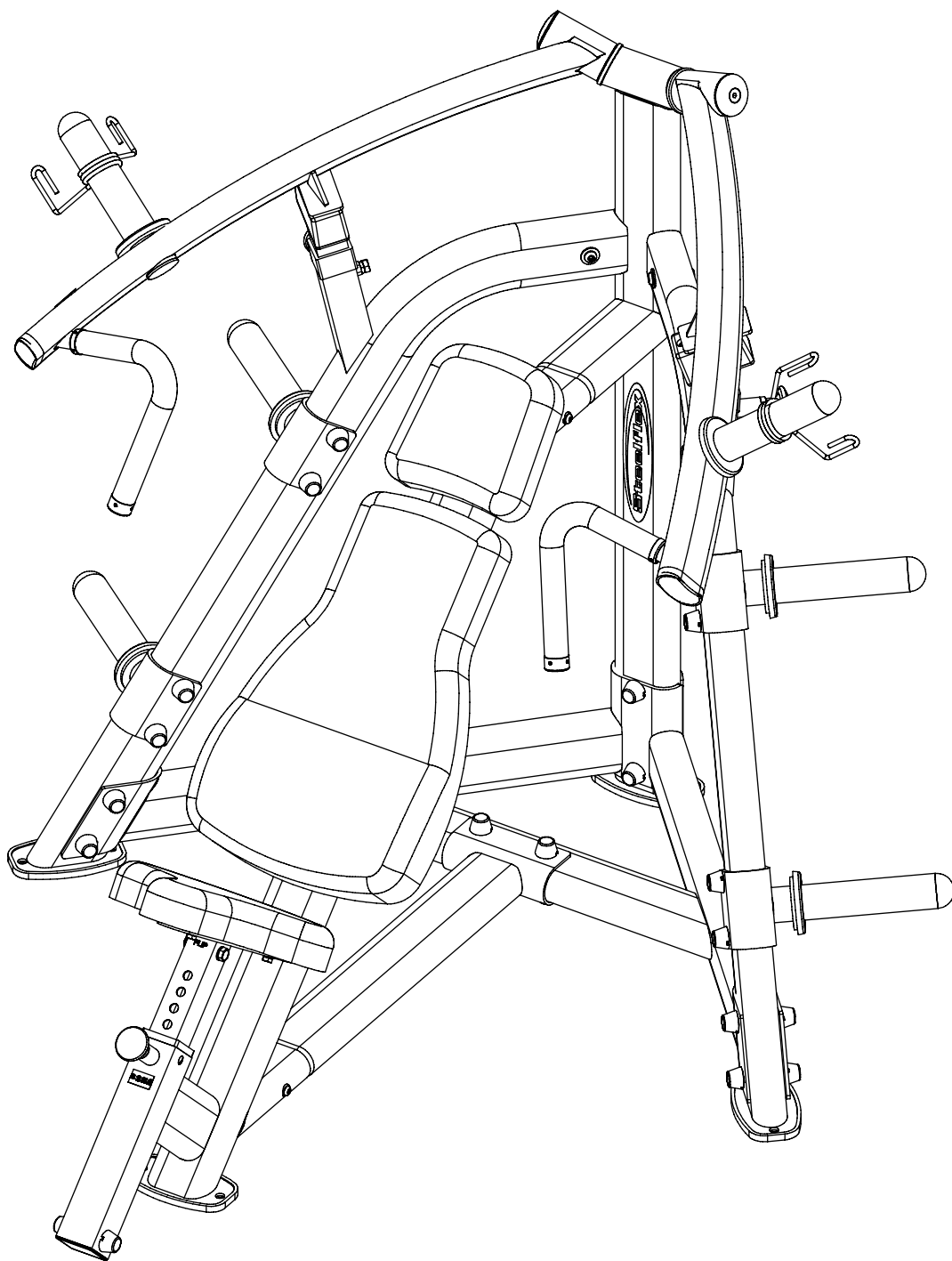

Assembly & Instructions  
**OWNER'S & MANUAL**

# PLIP HARDWARE

(shown in actual size)

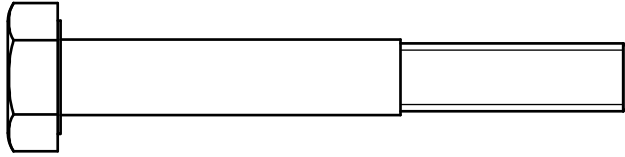
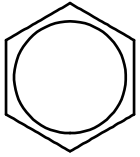

A1. M10x75 HEX HEAD SCREW...9PCS

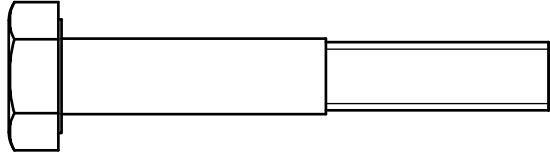
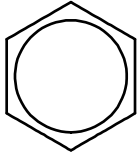

A2. M10x65 HEX HEAD SCREW...9PCS

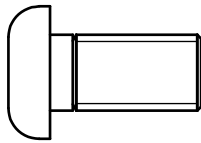
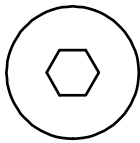

A3. M10x20 ALLEN SCREW(FULL THREAD)...4PCS

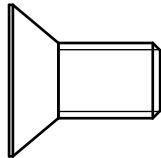
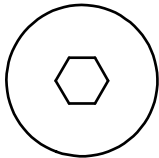

A4. M10x20 TAPER SCREW(FULL THREAD)...2PCS

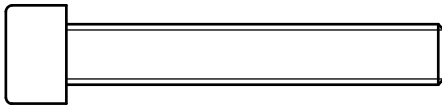
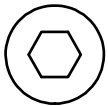

A5. M8x50 SOCKET SCREW(FULL THREAD)...4PCS

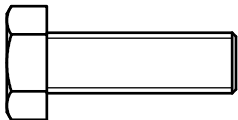
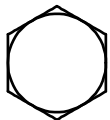

A6. M8x25 HEX HEAD SCREW...9PCS

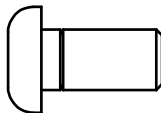
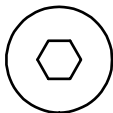

A7. M8x16 ALLEN SCREW(FULL THREAD)...8PCS

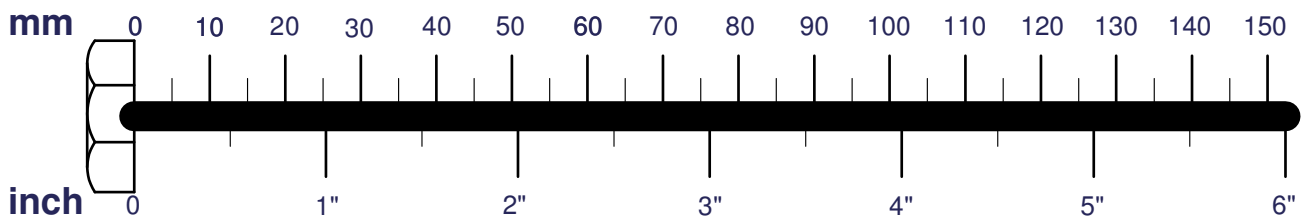

# A2 M PLIP HARDWARE 8PCS

(shown in actual size)

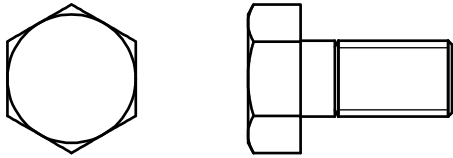

A8. M10x20 HEX HEAD SCREW...2PCS (Pre-installed)



A9. M5x5 GRUB SCREW...8PCS (Pre-installed)

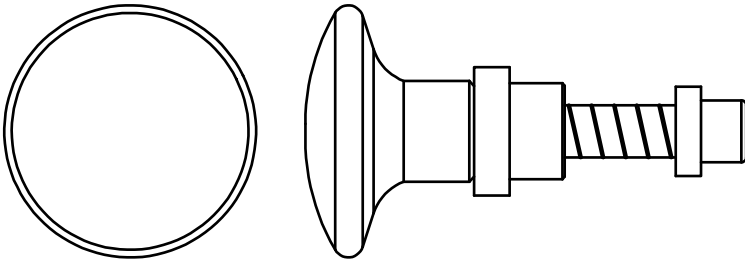

A10. 1/2"x87.5L POP PIN (8250-124G)...2PCS (Pre-installed)

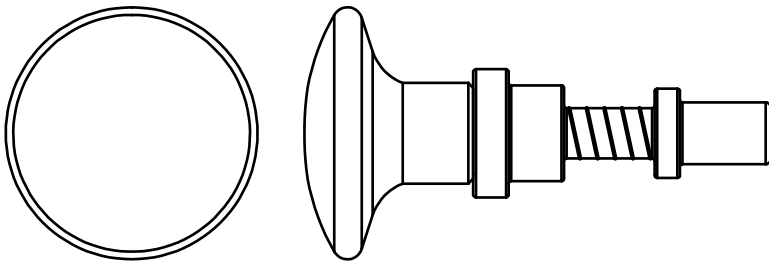

A11. 1/2"x92.5L POP PIN (8250-065G)...1PCS (Pre-installed)

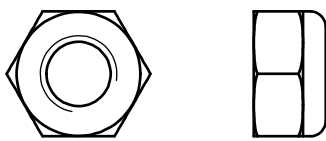

B1. M10 NYLON LOCK NUT...10PCS

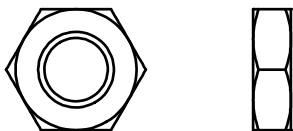

B2. M10 LOCK NUT(5t)...2PCS (Pre-installed)

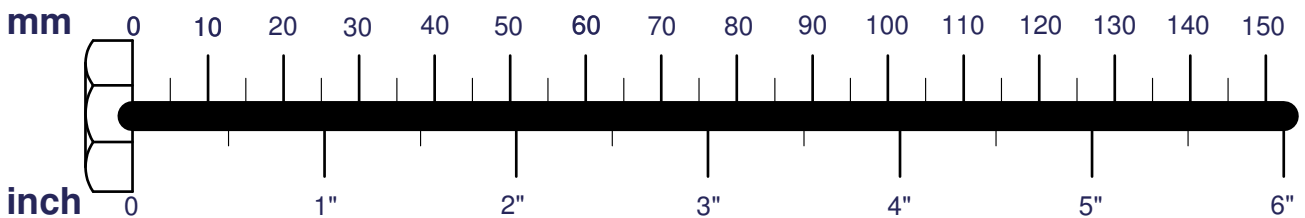

# PLIP HARDWARE

(shown in actual size)

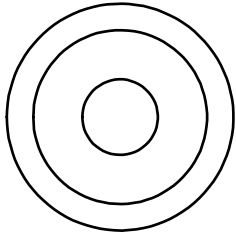

C1. M10 PLATE WASHER(Ø30)...26PCS(Pre-installed 2PCS)

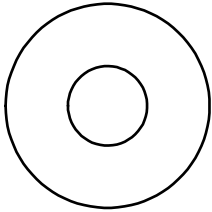

C2. M10 WASHER(Ø27)...4PCS

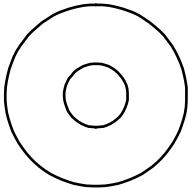

C4. M8 WASHER...13PCS

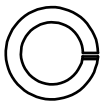

C5. M8 SPRING WASHER...9PCS

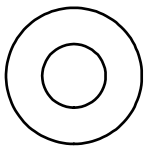

C6. M8 CURVED WASHER...4PCS

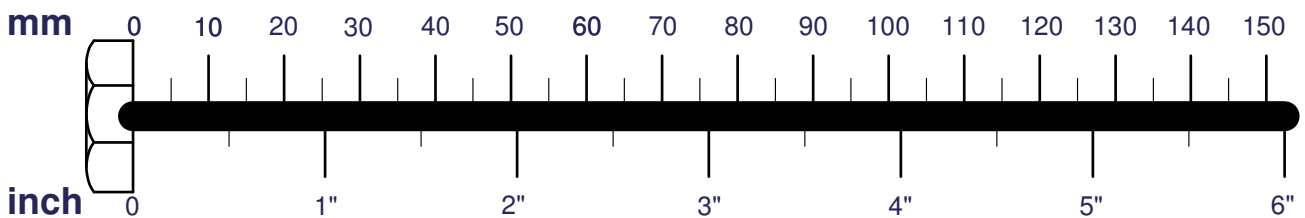

# PLIP PARTS

A [1PCS]

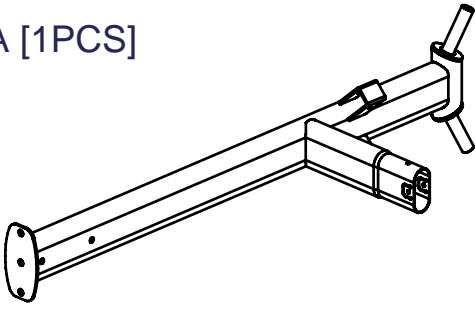

B [1PCS]

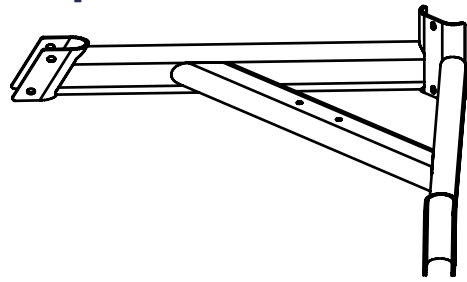

C [1PCS]

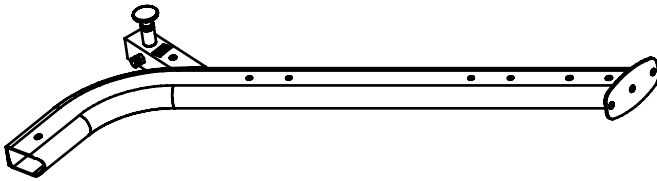

D [1PCS]

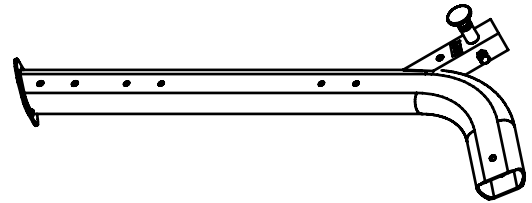

E [1PCS]

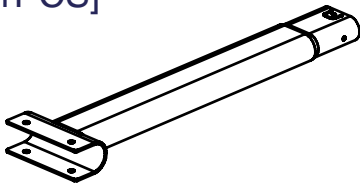

G [1PCS]

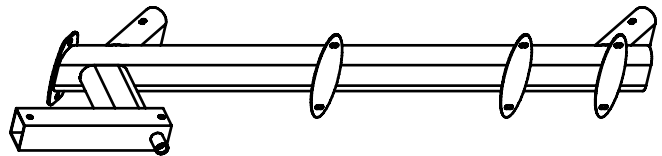

H [1PCS]

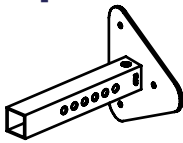

K [1PCS]

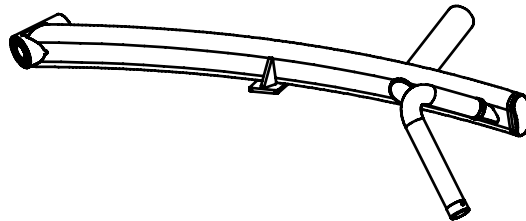

P [1PCS]  
8323188

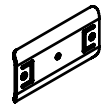

J [1PCS]

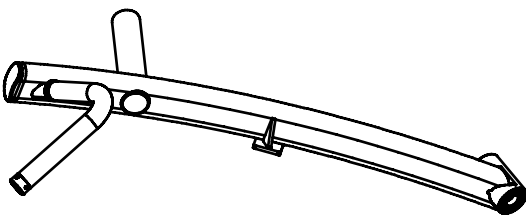

L [4PCS]  
6730001

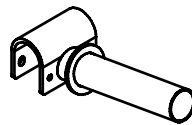

M [2PCS]  
6730003

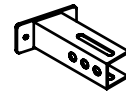

Q [1PCS]  
9111072

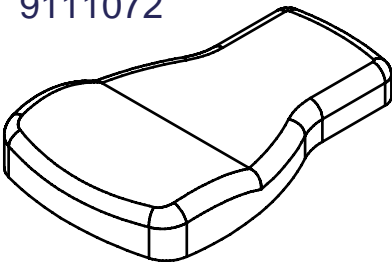

R [1PCS]  
9131025

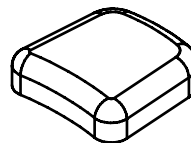

S [1PCS]  
9144016

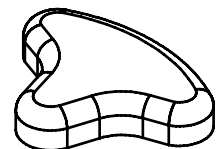

T [1PCS]  
8830023  
(pre-installed)

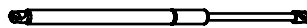

# PLIP PARTS

D1. End Closure (8130-248) .....	[2PCS]
D2. Compression Spring (8840-050) .....	[2PCS]
D3. Ø50 End Cap (9211-020) .....	[2PCS]
D4. Nylon Bushing (9211-030) .....	[2PCS]
D5. Ø50 End Cap (9211-074) .....	[6PCS]
D6. 40x80 End Cap (9211-113) pre-installed .....	[2PCS]
D7. 50x100 END CAP (9211-114) .....	[1PCS]
D8. Rubber Dount (9310-016) .....	[6PCS]
D9. Rubber Insert (9310-076) .....	[4PCS]
D10. Block Rubber (9310-077) .....	[2PCS]
D11. Pinch Cock (OC-06) .....	[2PCS]
D12. Cap Sleeve (9212-026).....	[26PCS]
D13. Co er Washer (8520-008) .....	[2PCS]
D14. Nylon Bushing (9211-047) .....	[1PCS]
D15. 60x60 END CAP (9211-049) .....	[1PCS]
D16. Chrome Collar (8890-061) pre-installed .....	[2PCS]
D17. Bearing (8510-037) pre-installed .....	[4PCS]
D18. Foam Grip (9162-102) pre-installed .....	[2PCS]
D19. Pulley spacer (8530-009).....	[2PCS]
D20. End Closure (8130-254)pre-installed.....	[2PCS]

D1



D2

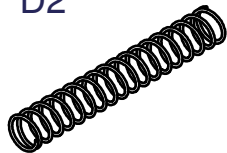

D3



D4

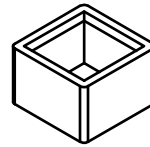

D5



D6



D7

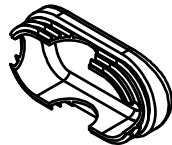

D8

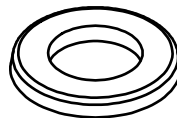

D9

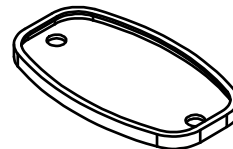

D10

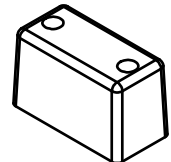

D11

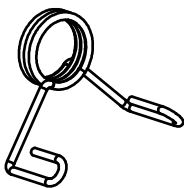

D12



D13



D14

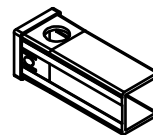

D15



D16



D17



D18

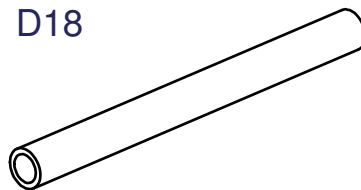

D19



D20



STEP  
**1**

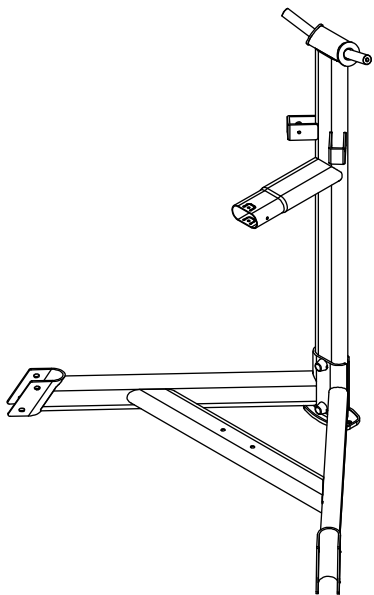

Above shows STEP 1  
assembled and completed

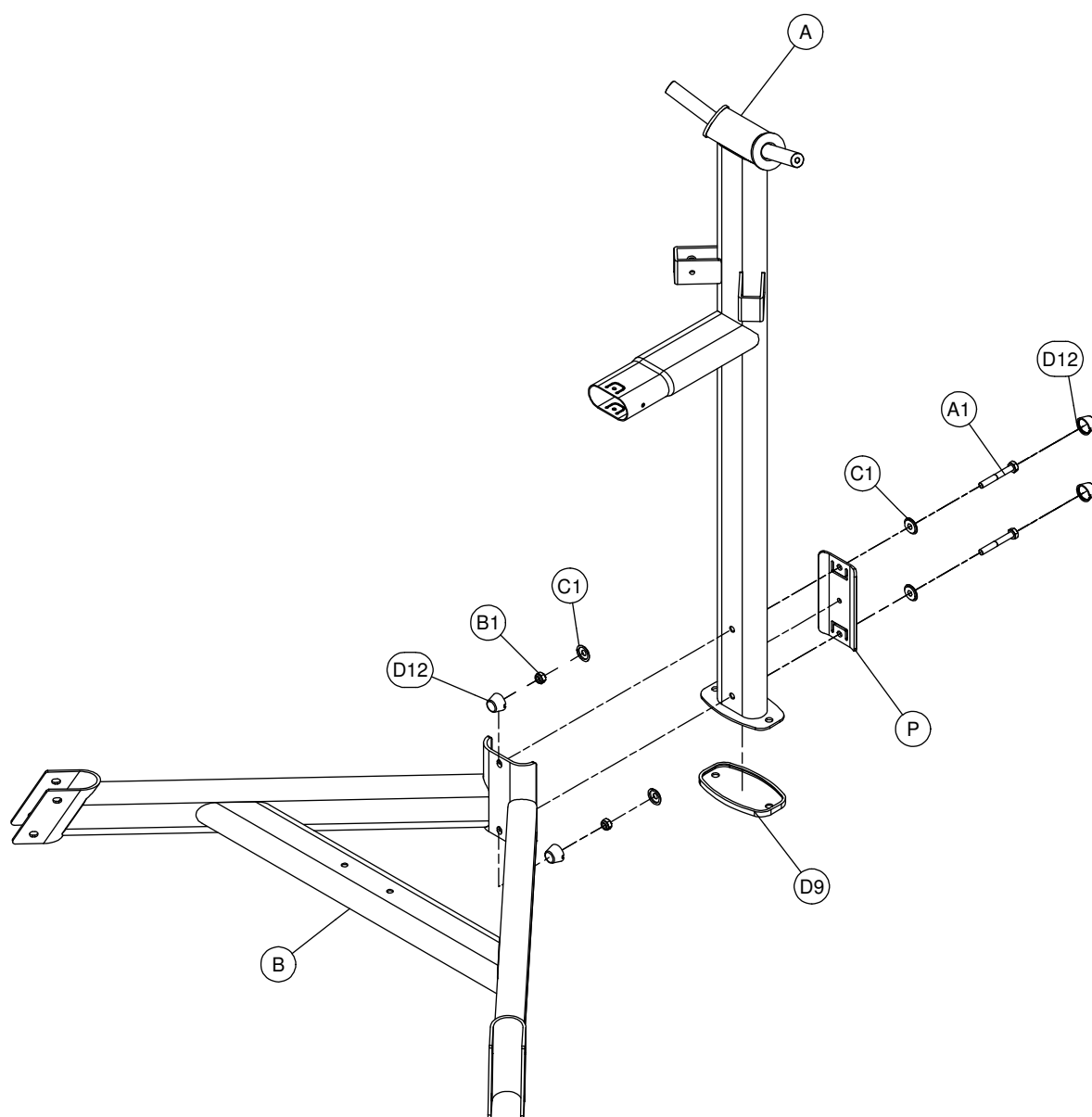

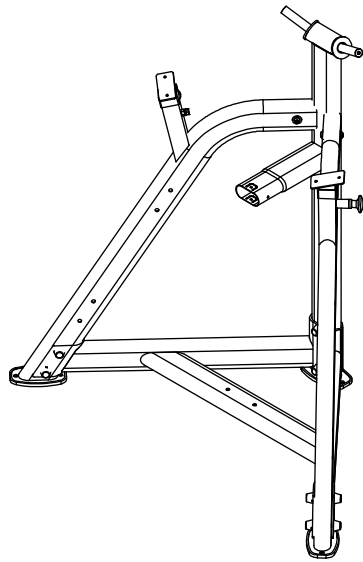

Above shows STEP 2 assembled and completed

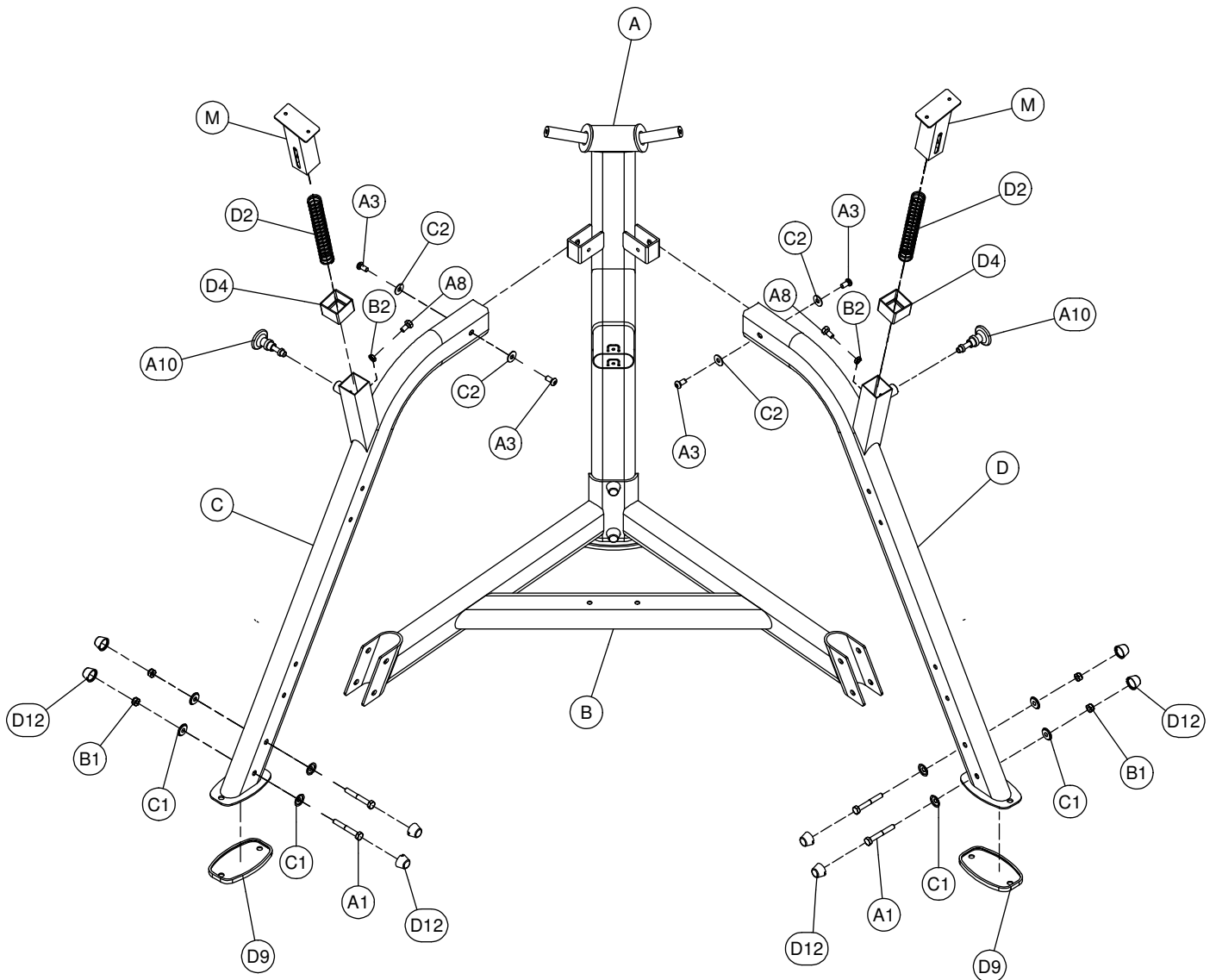



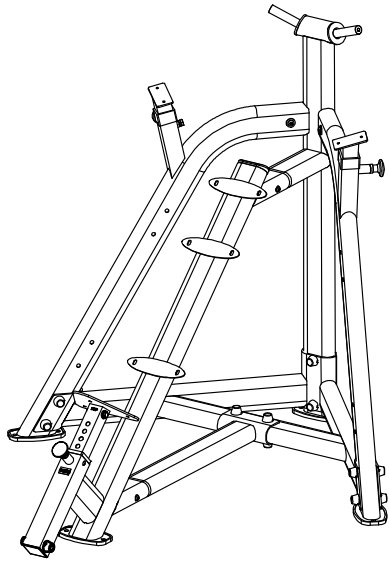

Above shows STEP 3 assembled and completed

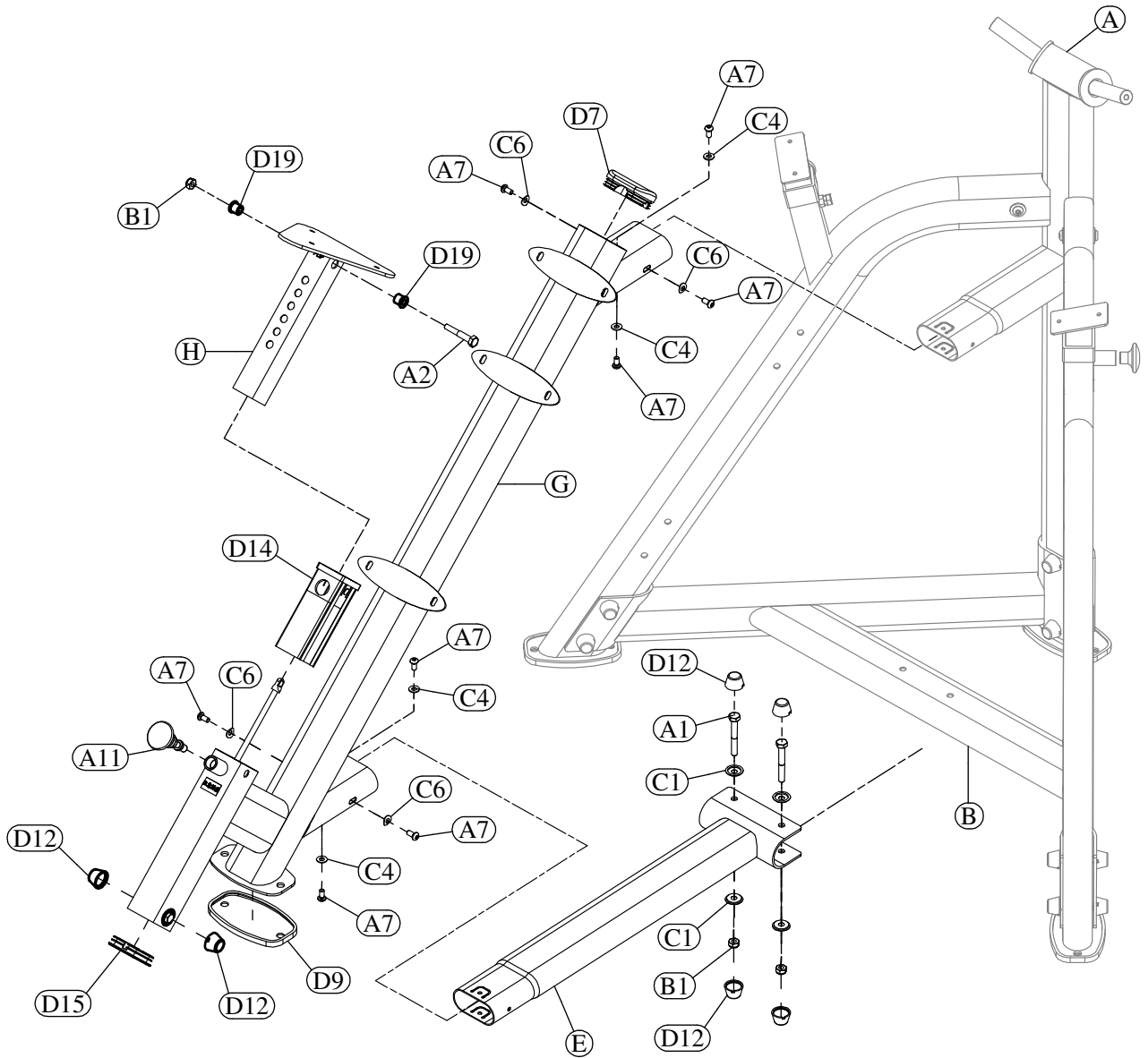

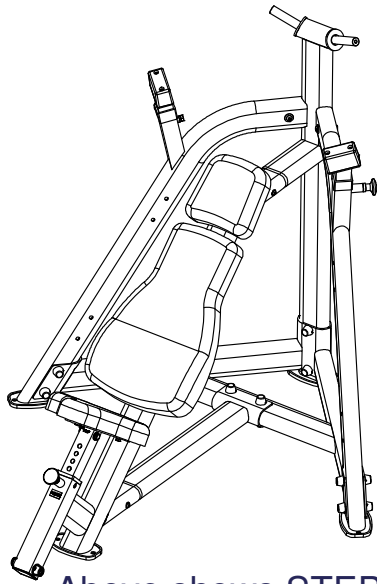

Above shows STEP 4 assembled and completed

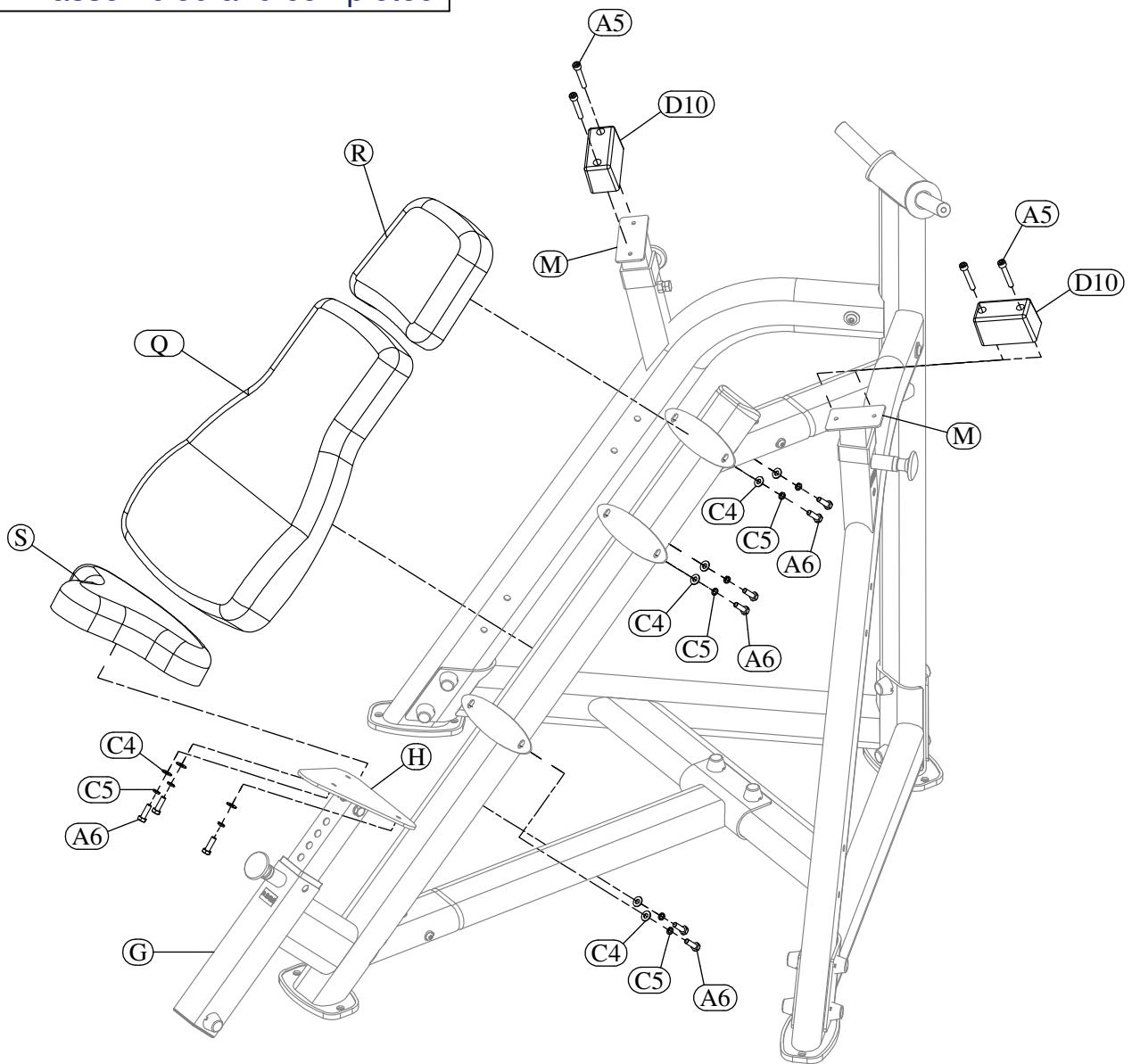

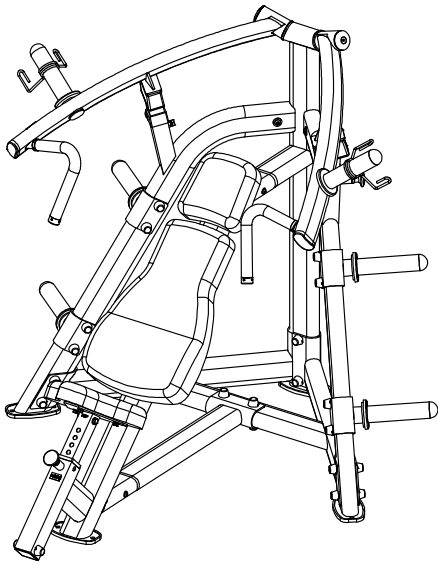

Above shows STEP 5  
assembled and completed

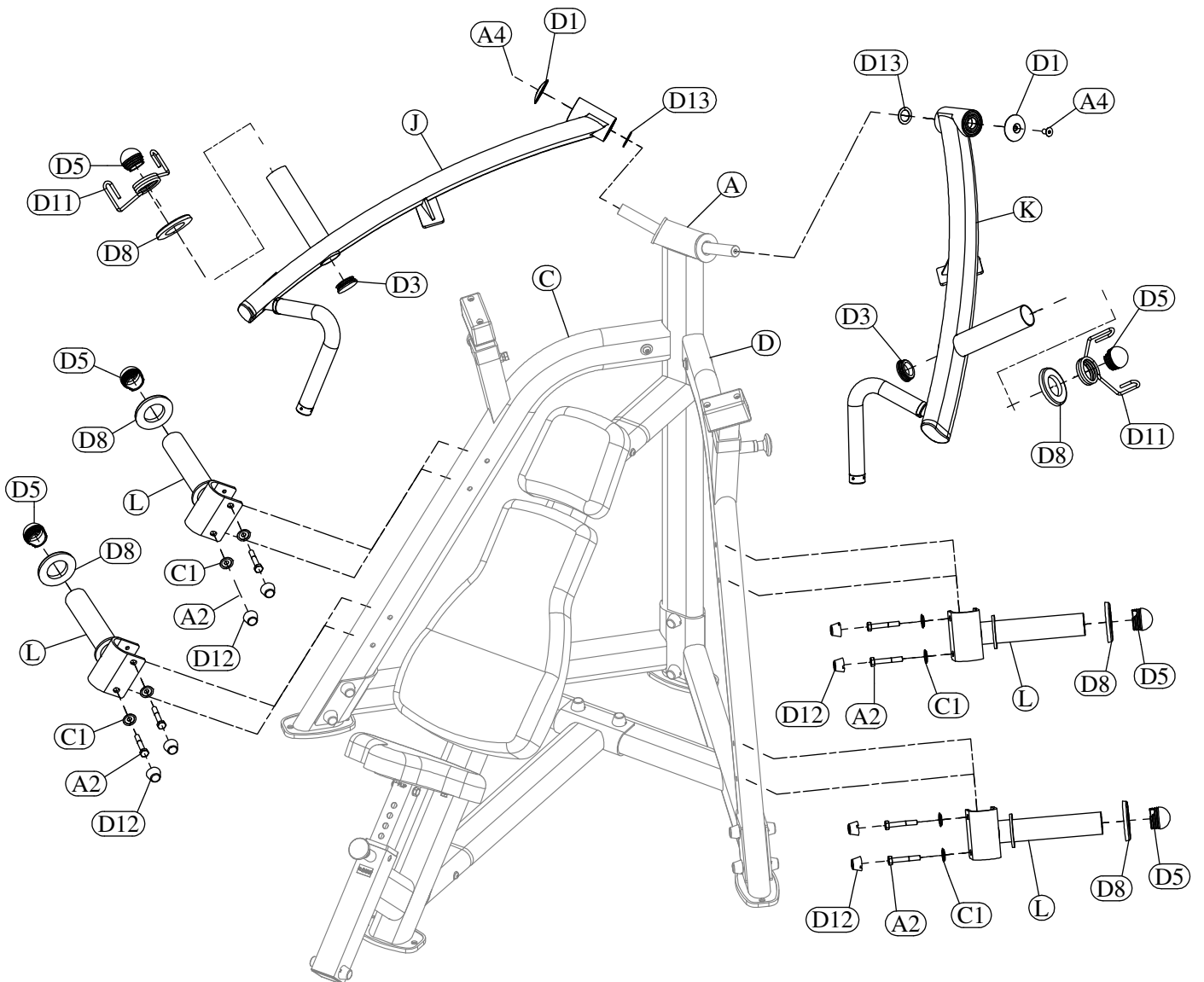

**PLIP-062009**

